

### DESCRIPTION

The Model 4806 GPIB <-> Serial Interface is a small, low cost interface board that interfaces RS-232 devices to the GPIB bus. The 4806 provides a smart IEEE-488.2 compliant, GPIB-to-serial conversion path and at the same time provides a serial connector that brings the existing RS-232 serial communications path out to the rear panel. The 4806's GPIB-to-serial data path can be set for any standard baud rate up to 57.6 kbaud and for all of the common asynchronous data formats. All configuration settings are user setable and are saved in the 4806's flash memory. The 4806 is typically mounted to the rear panel of the host chassis so the connectors can protrude through the rear panel or inside the host chassis. An on-card regulator lets the 4806 run on regulated or unregulated DC power.

Typical applications are adding a GPIB interface to a sensor or instrument that has a serial interface or adding an IEEE-488.2 interface to an embedded computer board.

### Dual Data Paths

Figure 1 shows the 4806's unique dual data paths. GPIB messages addressed to the 4806 are converted into serial messages and ORed with the external serial input to make the serial signal that goes to the serial device. Responses from the serial device go to both the external panel serial port (J2) and to the GPIB's serial input buffer. If the GPIB interface is being used, the responses are outputted on the GPIB bus when the 4806 is next addressed to talk. The 4806's external serial port provides a direct, full-duplex serial connection to the serial device that can be used when serial I/O is desired or for diagnostic purposes.

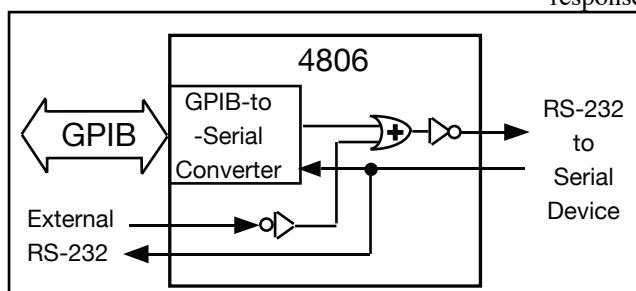
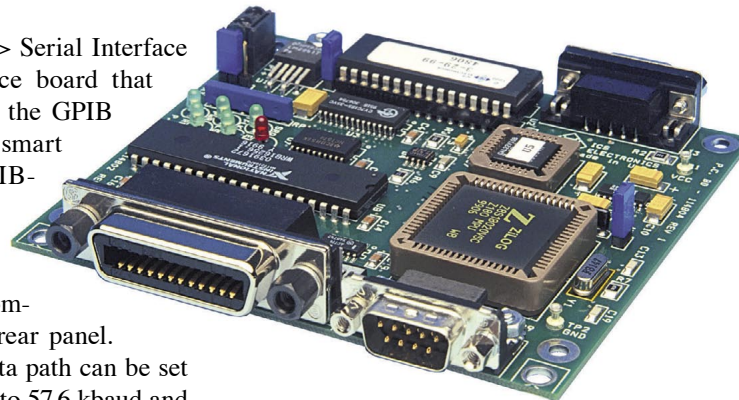

Figure 1 4806 Data Paths



4806 Showing Rear Panel Connectors

### Multiple Operating Modes

The 4806 has three operating modes to handle virtually any type of a serial device. In all cases, the 4806 passes all GPIB messages onto the serial device except for IEEE-488.2 commands and messages that start with four reserved SCPI keywords which are blocked from the serial device.

The ASYNC mode is for devices like serial transducers that periodically output a serial message. In the ASYNC mode, the 4806 saves the last message and outputs it on the GPIB bus when next asked for serial data.

The STANDARD mode is for the majority of serial devices that receive serial messages from a controller and may return a response to the controller. In the STANDARD mode, the 4806 saves the response and outputs it when addressed to talk.

The SMART mode is for communication with microcontrollers or embedded computers that can control the 4806's IEEE-488.2 interface. In the SMART mode, the 4806 passes GPIB messages to the serial device and receives back a response message for the GPIB Controller or an acknowledgment that the message was received. The 4806 saves the response and outputs it when addressed to talk. The embedded processor can request that the 4806 go to local to enable front panel controls, query the 4806's local/remote status, set/reset bits in the 4806's Status Reporting Structure to generate SRQs, and query/set the 4806's GPIB address.

- Provides GPIB-to-serial and serial-to-serial data paths for serial devices. *Adds a GPIB interface to any RS-232 serial device and maintains serial I/O.*
- Provides all IEEE-488.2 functions and the Status Reporting Structure. *Easiest way to add IEEE-488.2 capability to any serial device.*
- Smart firmware passes GPIB data to serial device. *Does not require escape sequences or a second GPIB address.*
- SCPI commands set serial configuration, GPIB address and IDN message. *Easy setup customizes the 4806 for the end product.*
- Mounts directly to host chassis's rear panel. *Easy installation eliminates extra cables and reduces cost.*
- Smart mode communicates with the internal serial device. *Operates as the front end for embedded controllers.*
- Includes menu driven configuration program. *The easy way to configure the interface.*

RoHS



7034 Commerce Circle  
Pleasanton, CA 94588  
Phone: 925.416.1000  
Fax: 925.416.0105  
Web: [www.icselect.com](http://www.icselect.com)

**Asynchronous Serial Device Operation** - 4806 passes all GPIB messages onto the serial device but blocks all IEEE-488.2 commands and messages that start with the four reserved SCPI keywords from the serial device. Serial device transmits periodic serial messages. 4806 saves only the last message and outputs it in response to the SYSTem:COMMunicate:SERial:RECEive:DATA? or RX? queries. Typical asynchronous devices are transducers or other measuring devices that just output periodic serial messages.

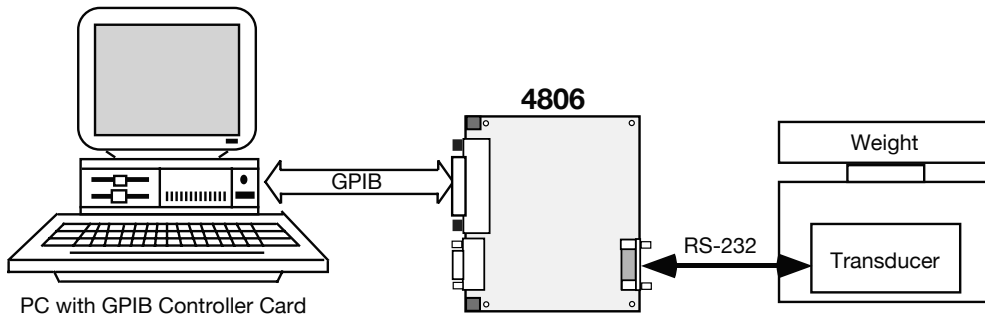

Figure 2(a) 4806 with a Serial Device that sends asynchronous messages

**Standard Serial Device Operation** - 4806 passes all GPIB messages onto the serial device but blocks all IEEE-488.2 commands and messages that start with the four reserved SCPI keywords from the serial device. The serial device only outputs response messages when queried. The 4806 saves the response messages and outputs them on the GPIB bus when next addressed to talk. This mode handles most serial devices that need a GPIB-to-Serial Interface without any programming modifications.

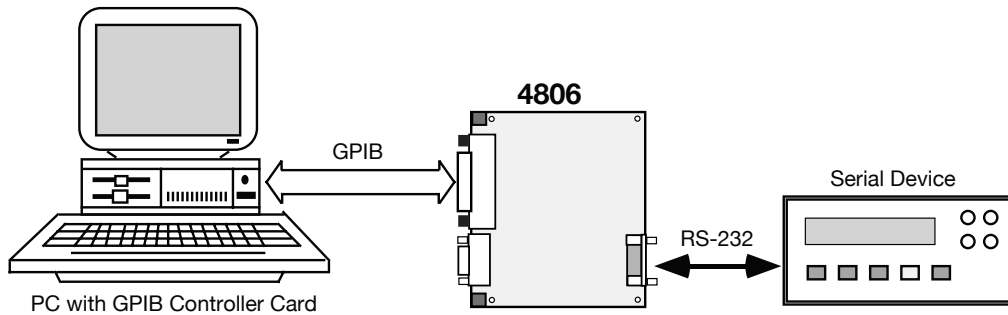

Figure 2(b) 4806 with a Standard Serial Device

**Smart Serial Device Operation** - 4806 passes all GPIB messages onto the serial device but blocks all messages that start with the four reserved SCPI keywords from the serial device. The 4806 responds to all IEEE-488.2 commands and sends copies of them to the serial device in case it needs to take some additional action. e.g. \*RST may be used to reset the system. The serial device must respond to each serial message within a preset timeout period but not to the IEEE-488.2 command copies. The serial device can send responses to the GPIB bus, can pass status information by setting bits in the 4806's 488.2 Status Structure, can set/query the 4806 GPIB address and can query the 4806's Local/Remote state. The serial device can request the 4806 to go to local to enable its' local controls. The 4806 can also notify the serial device whenever its local/remote state changes.

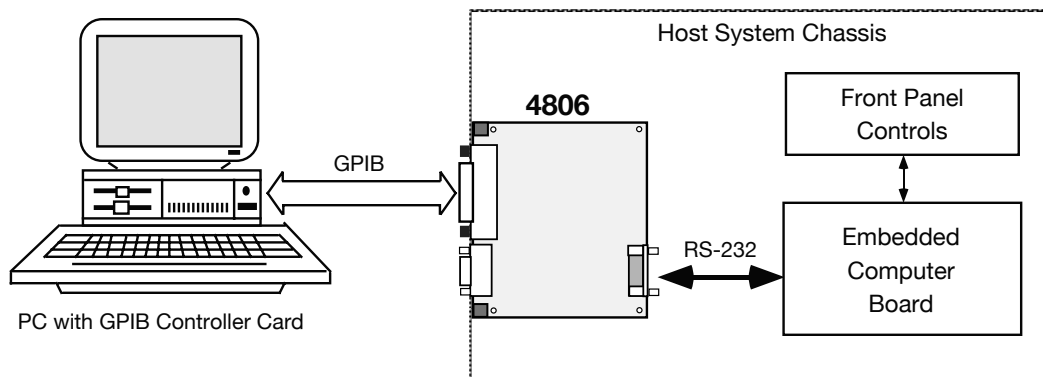

Figure 2(c) 4806 with a Smart Serial Device

**Basic Operation**

The 4806 GPIB-to-Serial Interface provides a smart data path from the GPIB bus to the serial device that is transparent to most data strings and at the same time provides responses to IEEE-488.2 and SCPI commands and queries for the serial device. The 4806 does this by examining the received GPIB messages and responding to any IEEE-488.2 commands or queries. Next the received GPIB message is checked to see if it is a SCPI command that starts with a reserved keyword. The four reserved SCPI keywords are: SYSTem, STATus, CALibrate and DIAGnostic. Messages containing the reserved words are not blocked if the reserved keywords do not start the data message. All remaining messages are placed in the serial output buffer and transmitted to the serial device.

In the Asynchronous mode, only the last message from the serial device is saved and outputted to the GPIB bus when the 4806 is addressed to talk. This assures that the user gets the latest message. In the Standard mode, any reply is saved and outputted on the GPIB bus when the 4806 is next addressed to talk. If the serial device does not reply within a preset time period, the 4806 assumes that there is no reply and prepares to accept the next GPIB bus message.

**Smart Device Operation**

The Smart Device mode is similar to the Standard mode but adds a communication capability so the serial device can communicate with the 4806 to modify its operation. The messages in Table 1 let the Smart Serial Device pass device status information to the GPIB Controller by setting or resetting bits in the 4806's Questionable, Operation and ESR registers, query or set the 4806's GPIB address and set the IDN response string. The Smart Device can query the 4806's remote-local status and request that the 4806 go to the local state to enable front panel controls. The 4806 can be set to send the serial device a message whenever it changes the local-remote state.

In the Smart Device mode, the 4806 also sends copies of the IEEE-488.2 commands the serial device in case the serial device needs to respond to the command. Examples are the \*RST command which may be used to reset the system or the \*OPC command which requests that a bit in the ESR register be set when the pending operation is finished.

When in the Smart device mode, the 4806 expects a reply to all messages sent

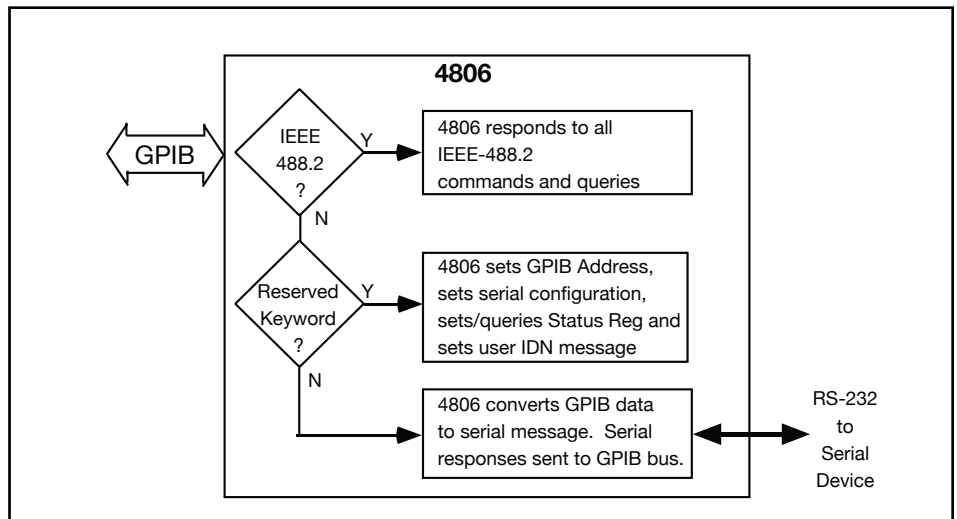

**Figure 3 4806 Operation Diagram**

**Table 1 Smart Device Messages**

Message	Meaning
@@@ESR value	Sets bits in the 4806 ESR register. Register reset when read
@@@OPERI value	ORs bits into the 4806 Operational Register.
@@@OPER& value	ANDs value with the Operational Register to reset bits.
@@@QUESI value	ORs bits into the 4806 Questionable Register
@@@QUES& value	ANDs value with the Operation Condition Register to reset bits.
@@@ADDR value	Sets 4806 GPIB address to new value.
@@@ADDR?	Queries current 4806 GPIB address setting.
@@@IDN string	Sets IDN response to user supplied string.
@@@SAV	Saves current configuration in flash. Same as *SAV 0 comd.
@@@REM?	Queries local/remote state. Responses are @@REM 1 for remote, 0 for local and 3 for remote-local lockout state.
@@@LOC?	Requests 4806 to go to local state. Same replies as for @@REM?
@@@NOREM	Disables automatic local remote change messages.
@@@LF	Tells 4806 to put a linefeed character in its GPIB buffer
@@@TO nnnn	Extends timeout by nnnn times to give the serial device more time to reply to the current query.
@@@OK	Message acknowledgment message. Used by 4806 and Smart device if the message they just received does not have another response.
@@@ERR	4806 received an invalid message.

to the serial device (except for the copies of the IEEE-488.2 commands). The 4806 also replies to all messages that it receives from the serial device. This keeps the two devices in sync. If a message does not have a response, then the @@@OK acknowledgment message is used as the response.

**4806 Configuration**

The 4806 is configured by sending it SCPI commands over the GPIB bus. The user can set the 4806's mode, serial baud rate, character format, the device response period and enter a custom IDN message to personalize the 4806 as part of the end product. These settings can be saved in flash memory and locked to prevent changes. The saved settings are recalled at power turn-on

as the new default configuration. The unit must be power cycled to update the serial settings.

The 4806's GPIB address can be set with a SCPI command from the GPIB bus or from the serial device when the 4806 is in the Smart device mode. The 4806's GPIB address setting cannot be locked so the end user can always change it. The GPIB address change takes affect immediately but must be saved if the change is to be permanent. When the Smart device changes the GPIB address, the 4806 performs an automatic save.

**4806 Status Reporting Structure**

Figure 4 shows the 4806's IEEE-488.2 Status Reporting Structure. In all of the modes, the 4806 sets and resets the ESR and Operational Register bits based upon conditions that it detects. The user can enable SRQ generation by setting the corresponding bits in the ESE, Operational Enable and SRE registers so that a true condition will generate a Service Request and assert the SRQ line. The Operational Register also has a Transition Register which can select positive or negative bit transitions to set the Event Register. Querying the ESR or the Operational Event register resets its bits. The bits in the Operational Condition Register are reset when the condition changes. For more information about the IEEE-488.2 Status Structure, refer to ICS's Application Bulletin AB48-11.

In the Smart device mode, the designer can define the unused bits in the Questionable and Operational Registers to report product status conditions to the GPIB controller. The Smart serial device can then set and reset these bits in the Questionable and Operational Condition Registers as the product status changes. The end user can enable the bits to generate an SRQ or can periodically query either register.

The Smart serial device can also set bits in the ESR register to indicate receipt of a command error or to indicate that the commanded action has been completed. ESR bits are reset when the register is read.

**Rear Panel Mounting**

The 4806 mounts perpendicular to the rear panel so that the GPIB and serial connectors protrude through the rear panel. The 4806 is held against the rear panel by two screws that blot to mounting blocks and the four lock studs on the GPIB and Serial connectors. Figure 5 shows the panel cutouts. Figure 6 shows the 4806 board outline dimensions.

**4816 Connections**

The 4806 user connects to the GPIB Connector or to the external serial connector (J2). At power turn-on, the GPIB to serial path remains dormant until the 4806 detects the presence of a GPIB Controller so the serial to serial path can be used. Both connectors may not be used at the same time.

The 4806's internal serial connector (J3) is for RS-232 connections to the serial device. On board jumpers reverse the TX

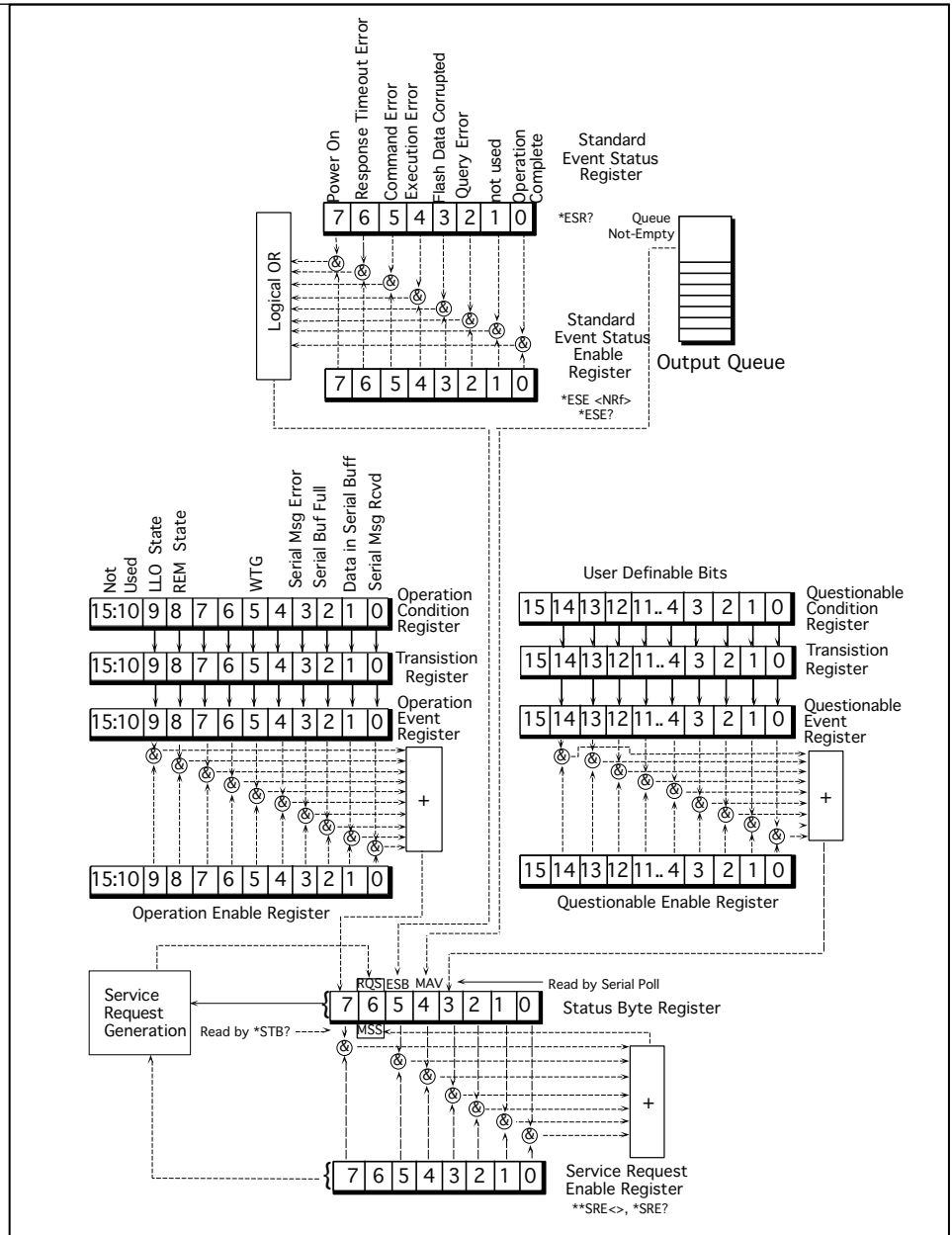

**Figure 4 4806 IEEE-488.2 Status Reporting Structure.**

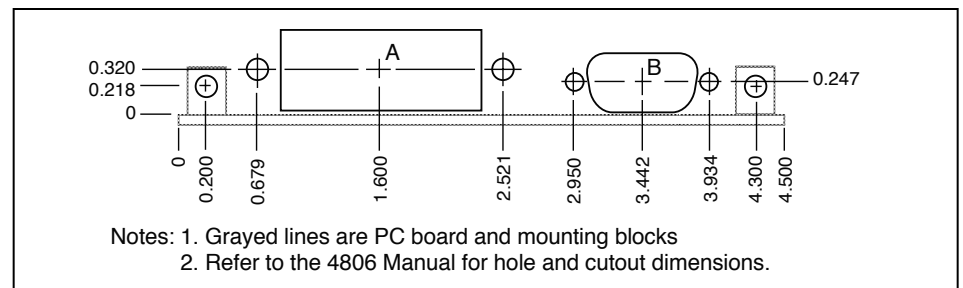

**Figure 5 Rear panel Mounting Dimensions**

and RX signal pin assignments for DTE and DCE devices

The 4806 includes a low voltage dropout regulator for operating from unregulated 5.5 to 15 volt DC power. A jumper bypasses the regulator for operation from regulated 5 Vdc power.

**4806 Starter Kit**

ICS offers a Starter Kit for the 4806 that includes the 4806 Board, a 488-LPCI GPIB PCI Card or a 488-USB2 GPIB Controller, a GPIB Bus Cable, mating connectors for the 4806, Manuals, 488.2V3 Drivers and software. Limit of one Starter Kit per customer.

## 4806: SPECIFICATIONS

### IEEE 488 Bus Interface

The 4806's 488 Bus Interface meets IEEE STD 488.1-1987 and has the following capabilities as a GPIB-to-Serial converter:

- SH1, AH1, T5, L3, SR1, PP1, DC1
- RL0, DT0, C0 and E1/E2 drivers

Bus drivers incorporate power up/down protection to prevent glitching the bus during power turn-on.

### Address Capability

Primary addresses 0-30 set by GPIB bus command. Address displayed on LED indicators at power turn-on.

### SRQ Generation

SRQs are generated per the IEEE-488.2 specification when the unit is not addressed to talk and an enabled bit in the ESR, Questionable or Conditional register becomes set.

### Parallel Poll Response

Reports SRV Status in PPR bit

### Buffers and message lengths

- GPIB Input 256 bytes
- Serial Input 256 bytes

### 488.2 Common Commands

\*CLS, \*ESE, \*ESE?, \*ESR?, \*IDN?, \*OPC, \*OPC?, \*RST, \*SAV, \*SRE, \*SRE?, \*STB, \*TST?, AND \*WAI.

### Serial Interface

Serial signals conform to EIA Specifications for RS-232 signals. External connector is a DTE type interface with DTR and RTS signals pulled to +V. Internal connector is a DCE/DTE type interface with DSR and DCD signals pulled to +V.

Signals	Txd, Rxd, Gnd
Baud Rates:	50 to 57.600 baud
Data Bits	7 or 8 bits
Parity	Odd, even or none
Stop Bits	1 or 2

Pin#	J2 (DE-9P) Signal	J3 (DE-9S) Signal
1	DCD	DCD →
2	RxD ←	TxD →
3	TxD →	RxD ←
4	DTR →	DTR
5	Gnd	Gnd
6	DSR	DSR →
7	RTS →	□
8	CTS	□
9	-	-

Notes ← = in, → = out, □ = jumper

### SCPI Commands

The 4806 conforms to the SCPI 1994.0 Specification and uses SCPI commands to set its configuration: The reserved SCPI Keywords are:

SYSTEM  
STATUS  
CALIBRATE  
DIAGNOSTIC

### Indicators

Six on board LEDs show selftest diagnostics, GPIB address and status.

- PWR On when power applied
- RDY On when Selftest passed
- MTA On when talk address recognized
- MLA On when listen address recognized
- SRQ On when SRQ generated
- ERR On when ESR error bit set

### Physical

Size, L x W x H  
101.6 x 114.3 x 17.9 mm  
(4.0 x 4.5 x 0.7 inches)

### Connectors

- GPIB: 24-pin IEEE-488 connector with metric lock studs.
- Ext. Serial: 9-pin DE shell male connector with 4-40 lock studs.
- Device: 9-pin DE shell female connector with 4-40 lock studs.

### Construction

Four layer PCB. Connector shells are connected to chassis ground.

### Temperature

- Operation -10 °C to +70 °C
- Storage -40 °C to +85 °C

### Humidity

0-90% RH without condensation

### Power

- +5 Vdc or 5.5 to 18 Vdc
- 240 mA (typ.)

### Included Accessories

- Instruction Manual
- Configuration Disk with sample programs

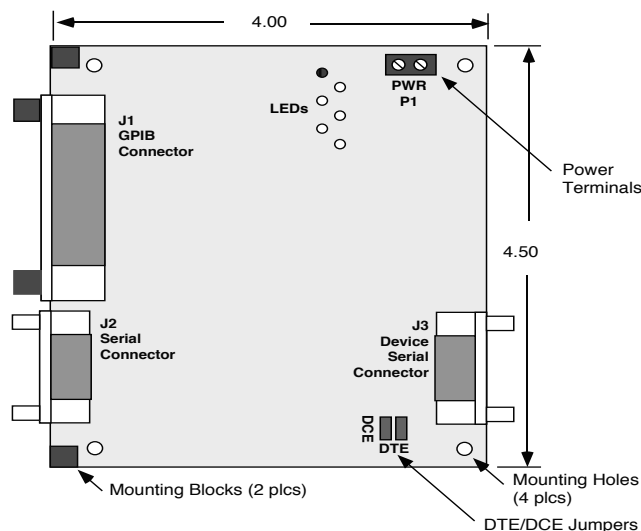

Figure 6  
4806 Outline  
Dimensions

## ORDERING INFORMATION

	Part Number
GPIB - Serial Interface Board (includes Manual and Configuration Disk)	4806
GPIB - Serial Interface Board (Board only) -01 DCE jumper setting standard, -02 DTE jumper setting	114802
4806 Starter Kit includes 4806, 488-LPCI PCI GPIB Controller card, Cables, Manuals and CD-ROM	114808-01
4806 Starter Kit includes 4806, 488-USB2 GPIB Controller, Cables, Manuals and CD-ROM	114808-02